



ALFABETİK SIRALAMA - SÖZLÜK SIRASI

- ❖ Alfabetik sıralama için önce kelimelerin ilk harflerine bakarız. Eğer kelimelerin ilk harfleri aynı ise ikinci harflerine bakarız. İkinci harfi de aynı olan kelimelerde sırasıyla diğer harflere bakarız.

A B C Ç D E F G Ğ H I İ J K L M N O Ö P R S Ş T U Ü V Y Z



ALİŞTIRMALAR

Aşağıda görselleri verilen varlıkların adlarını yazınız. Görsel çiftlerinden hangisinin adı sözlükte diğerinden önce gelir? İşaretleyiniz.

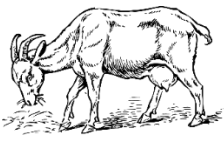
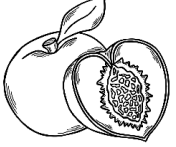

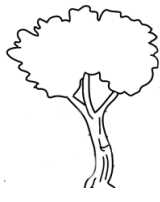
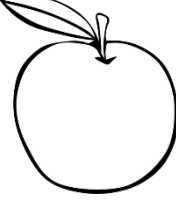
	
Tavuk	X Gömlek

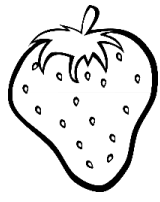
	
.....

	
.....

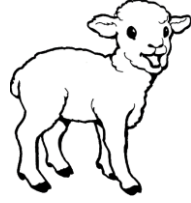
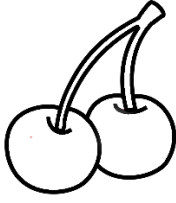
	
.....

	
.....

	
.....

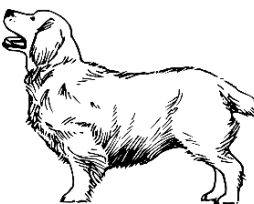
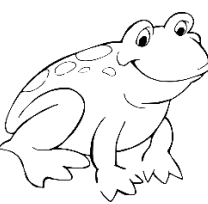
	
.....

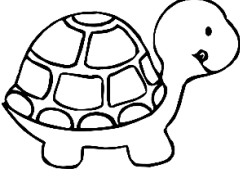
	
.....