

Uzamsal İlişkiler

Aşağıdaki masanın üstüne bir çiçek çizin. Altına ise bir top çizin.

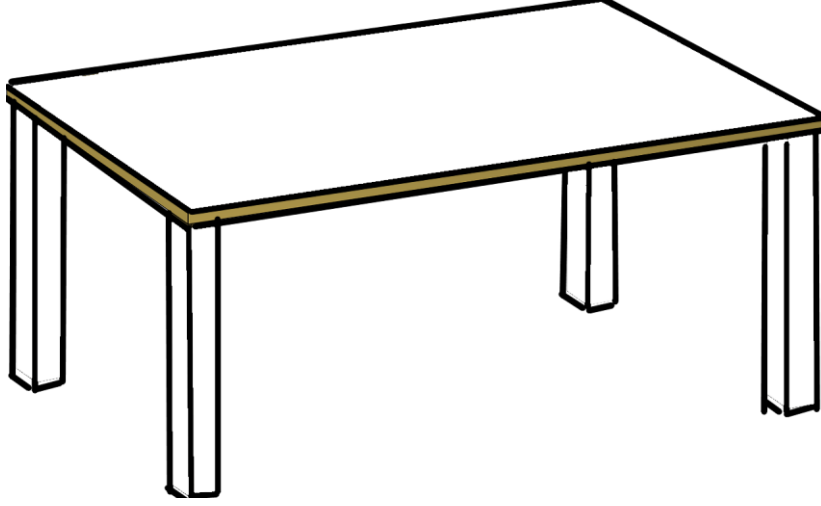

Aşağıdaki topun etrafına misketler çizin.



Evlerin arasına bir tane ağaç çizin ve ağacı boyayın.

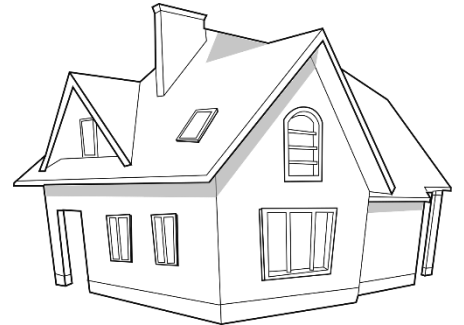

Çadırın önündeki masayı maviye, arkasındaki masayı kırmızıya boyayınız.



Yüksekte olan balonu yeşile, alçakta olan balonu pembeye boyayınız.

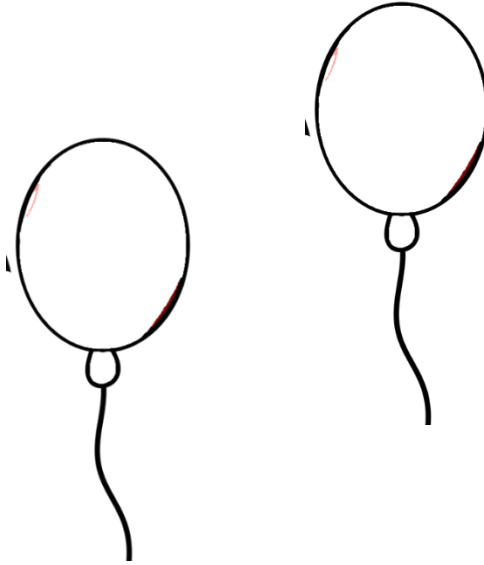

Aşağıdaki ağacın yakınına bir çiçek, uzağına ise bir ev çiziniz.

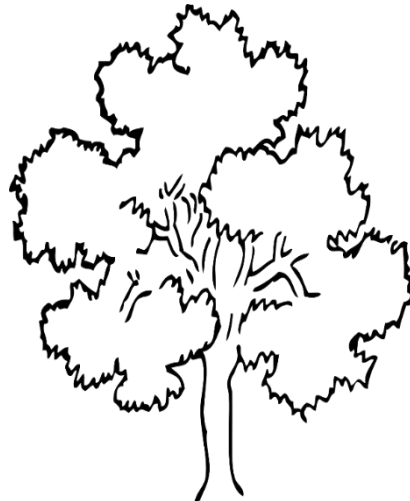

Aşağıdaki havuzun içine bir top dışına ise bir çiçek çiziniz.

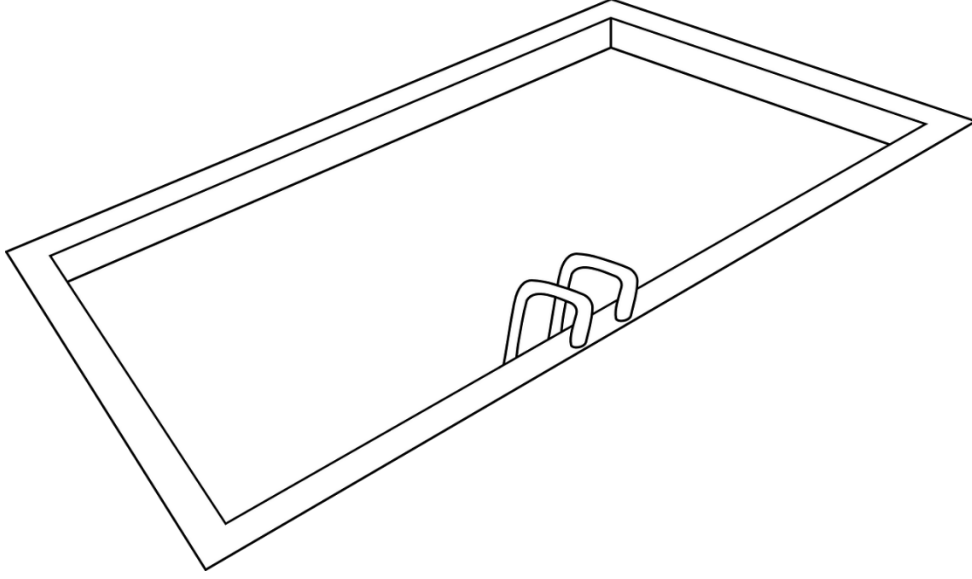

Aşağıdaki ceketin sağında yer alan düğmeleri sarıya, solunda yer alan düğmeleri ise maviye boyayınız.

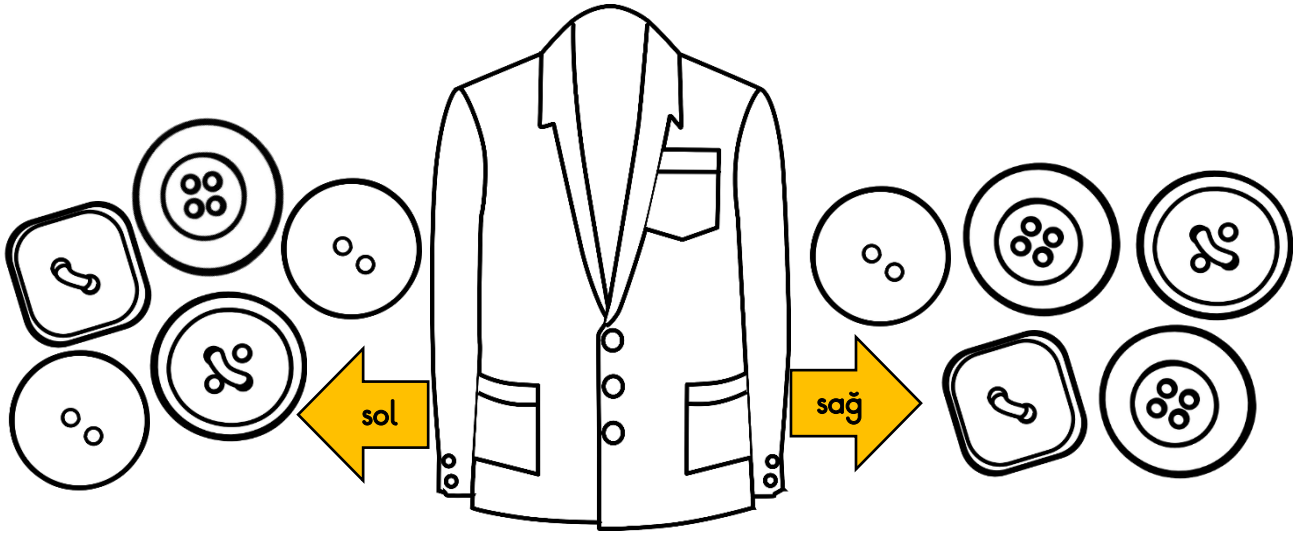

Sol baştaki silgiye eş olan silgiyi bulup altındaki kutucuğu işaretleyiniz.

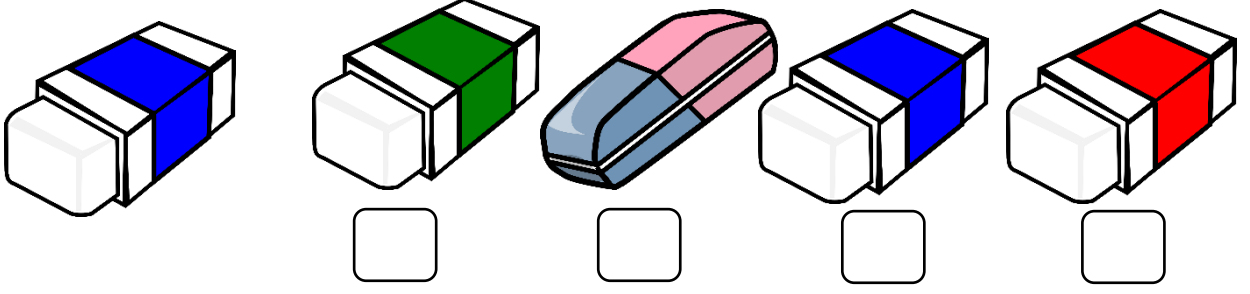

Sol başta verilen kalemin eşini bulup yuvarlak içine alınız.



Eş olan düğmeleri aynı renge boyayınız.

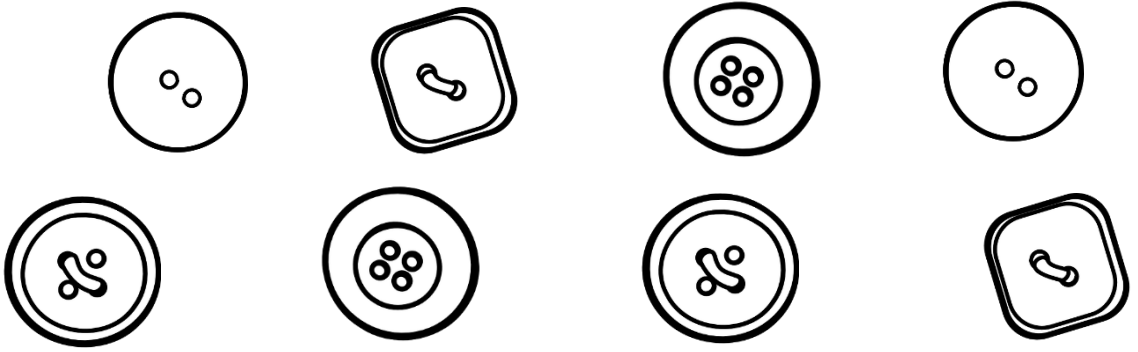

Aşağıdaki şekillerden eşi olmayanı maviye boyayınız.

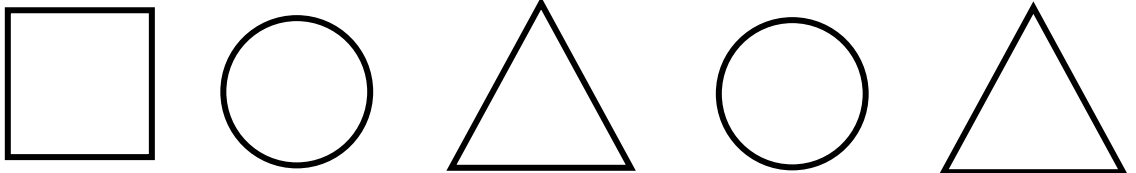

Eş olan nesneleri eşleştiriniz.

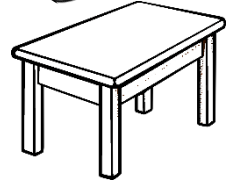
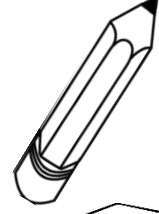
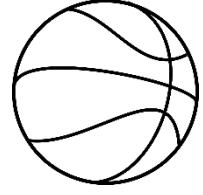
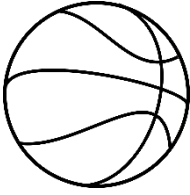
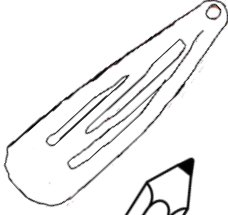
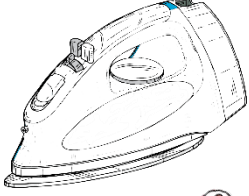
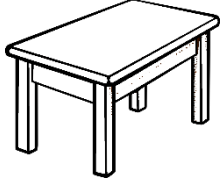

Aşağıdaki iki resim eş midir? Neden?

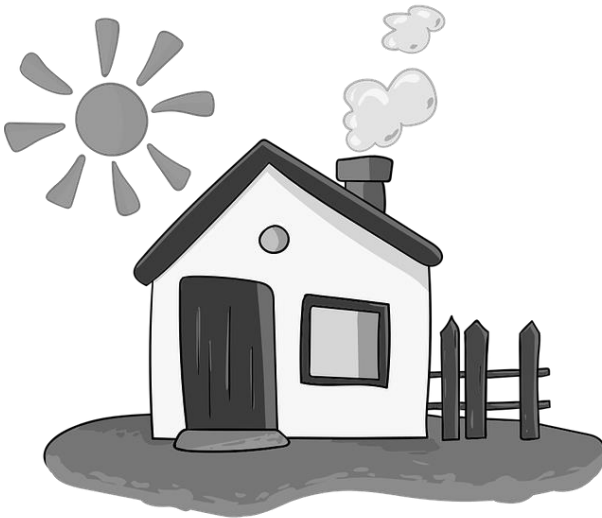

Eş olma durumunu bozan farklılıkları bulunuz.